

▶ BSE792220B
BSE792220M

EN **User Manual**
Steam oven

USER MANUAL



AEG

CONTENTS

1. SAFETY INFORMATION.....	2
2. SAFETY INSTRUCTIONS.....	4
3. PRODUCT DESCRIPTION.....	7
4. CONTROL PANEL.....	8
5. BEFORE FIRST USE.....	10
6. DAILY USE.....	11
7. CLOCK FUNCTIONS.....	23
8. AUTOMATIC PROGRAMMES.....	24
9. USING THE ACCESSORIES.....	24
10. ADDITIONAL FUNCTIONS.....	27
11. HINTS AND TIPS.....	28
12. CARE AND CLEANING.....	53
13. TROUBLESHOOTING.....	57
14. ENERGY EFFICIENCY.....	60

FOR PERFECT RESULTS

Thank you for choosing this AEG product. We have created it to give you impeccable performance for many years, with innovative technologies that help make life simpler features you might not find on ordinary appliances. Please spend a few minutes reading to get the very best from it.

Visit our website for:



Get usage advice, brochures, trouble shooter, service information:

www.aeg.com/webselfservice



Register your product for better service:

www.registeraeg.com



Buy Accessories, Consumables and Original spare parts for your appliance:

www.aeg.com/shop

CUSTOMER CARE AND SERVICE

Always use original spare parts.

When contacting our Authorised Service Centre, ensure that you have the following data available: Model, PNC, Serial Number.

The information can be found on the rating plate.

 Warning / Caution-Safety information

 General information and tips

 Environmental information

Subject to change without notice.

1. SAFETY INFORMATION

Before the installation and use of the appliance, carefully read the supplied instructions. The

manufacturer is not responsible for any injuries or damages that are the result of incorrect installation or usage. Always keep the instructions in a safe and accessible location for future reference.

1.1 Children and vulnerable people safety

- This appliance can be used by children aged from 8 years and above and persons with reduced physical, sensory or mental capabilities or lack of experience and knowledge if they have been given supervision or instruction concerning the use of the appliance in a safe way and understand the hazards involved.
- Do not let children play with the appliance.
- Keep all packaging away from children and dispose of it appropriately.
- Keep children and pets away from the appliance when it operates or when it cools down. Accessible parts are hot.
- If the appliance has a child safety device, this should be activated.
- Children shall not carry out cleaning and user maintenance of the appliance without supervision.
- Children aged 3 years and under must be kept away from this appliance when it is in operation at all times.

1.2 General Safety

- Only a qualified person must install this appliance and replace the cable.
- **WARNING:** The appliance and its accessible parts become hot during use. Care should be taken to avoid touching heating elements. Children less than 8 years of age shall be kept away unless continuously supervised.
- Always use oven gloves to remove or put in accessories or ovenware.
- Before carrying out any maintenance, disconnect the appliance from the power supply.

- Ensure that the appliance is switched off before replacing the lamp to avoid the possibility of electric shock.
- Do not use a steam cleaner to clean the appliance.
- Do not use harsh abrasive cleaners or sharp metal scrapers to clean the glass door since they can scratch the surface, which may result in shattering of the glass.
- If the mains power supply cable is damaged, it must be replaced by the manufacturer, its Authorised Service Centre or similarly qualified persons to avoid an electrical hazard.
- To remove the shelf supports first pull the front of the shelf support and then the rear end away from the side walls. Install the shelf supports in the opposite sequence.
- Use only the food sensor (core temperature sensor) recommended for this appliance.

2. SAFETY INSTRUCTIONS

2.1 Installation



WARNING!

Only a qualified person must install this appliance.

- Remove all the packaging.
- Do not install or use a damaged appliance.
- Follow the installation instructions supplied with the appliance.
- Always take care when moving the appliance as it is heavy. Always use safety gloves and enclosed footwear.
- Do not pull the appliance by the handle.
- Keep the minimum distance from other appliances and units.
- Make sure that the appliance is installed below and adjacent safe structures.
- The sides of the appliance must stay adjacent to appliances or units with the same height.

2.2 Electrical connection



WARNING!

Risk of fire and electric shock.

- All electrical connections should be made by a qualified electrician.
- The appliance must be earthed.
- Make sure that the parameters on the rating plate are compatible with the electrical ratings of the mains power supply.
- Always use a correctly installed shockproof socket.
- Do not use multi-plug adapters and extension cables.
- Make sure not to cause damage to the mains plug and to the mains cable. Should the mains cable need to be replaced, this must be carried out by our Authorised Service Centre.
- Do not let mains cables touch or come near the appliance door, especially when the door is hot.
- The shock protection of live and insulated parts must be fastened in

such a way that it cannot be removed without tools.

- Connect the mains plug to the mains socket only at the end of the installation. Make sure that there is access to the mains plug after the installation.
- If the mains socket is loose, do not connect the mains plug.
- Do not pull the mains cable to disconnect the appliance. Always pull the mains plug.
- Use only correct isolation devices: line protecting cut-outs, fuses (screw type fuses removed from the holder), earth leakage trips and contactors.
- The electrical installation must have an isolation device which lets you disconnect the appliance from the mains at all poles. The isolation device must have a contact opening width of minimum 3 mm.
- This appliance complies with the E.E.C. Directives.

2.3 Use



WARNING!

Risk of injury, burns and electric shock or explosion.

- This appliance is for household use only.
- Do not change the specification of this appliance.
- Make sure that the ventilation openings are not blocked.
- Do not let the appliance stay unattended during operation.
- Deactivate the appliance after each use.
- Be careful when you open the appliance door while the appliance is in operation. Hot air can release.
- Do not operate the appliance with wet hands or when it has contact with water.
- Do not apply pressure on the open door.
- Do not use the appliance as a work surface or as a storage surface.
- Open the appliance door carefully. The use of ingredients with alcohol can cause a mixture of alcohol and air.

- Do not let sparks or open flames to come in contact with the appliance when you open the door.
- Do not put flammable products or items that are wet with flammable products in, near or on the appliance.



WARNING!

Risk of damage to the appliance.

- To prevent damage or discoloration to the enamel:
 - do not put ovenware or other objects in the appliance directly on the bottom.
 - do not put aluminium foil directly on the bottom of cavity of the appliance.
 - do not put water directly into the hot appliance.
 - do not keep moist dishes and food in the appliance after you finish the cooking.
 - be careful when you remove or install the accessories.
- Discoloration of the enamel or stainless steel has no effect on the performance of the appliance.
- Use a deep pan for moist cakes. Fruit juices cause stains that can be permanent.
- This appliance is for cooking purposes only. It must not be used for other purposes, for example room heating.
- Always cook with the oven door closed.
- If the appliance is installed behind a furniture panel (e.g. a door) make sure the door is never closed when the appliance is in operation. Heat and moisture can build up behind a closed furniture panel and cause subsequent damage to the appliance, the housing unit or the floor. Do not close the furniture panel until the appliance has cooled down completely after use.

2.4 Steam Cooking



WARNING!

Risk of burns and damage to the appliance.

- Released Steam can cause burns:

- Be careful when you open the appliance door when the function is activated. Steam can release.
- Open the appliance door with care after the steam cooking operation.

2.5 Care and cleaning



WARNING!

Risk of injury, fire, or damage to the appliance.

- Before maintenance, deactivate the appliance and disconnect the mains plug from the mains socket.
- Make sure the appliance is cold. There is the risk that the glass panels can break.
- Replace immediately the door glass panels when they are damaged. Contact the Authorised Service Centre.
- Be careful when you remove the door from the appliance. The door is heavy!
- Clean regularly the appliance to prevent the deterioration of the surface material.
- Clean the appliance with a moist soft cloth. Only use neutral detergents. Do not use any abrasive products, abrasive cleaning pads, solvents or metal objects.
- If you use an oven spray, follow the safety instruction on it's packaging.
- Do not clean the catalytic enamel (if applicable) with any kind of detergent.

2.6 Internal lighting



WARNING!

Risk of electric shock.

- The type of light bulb or halogen lamp used for this appliance is for household appliances only. Do not use it for house lighting.
- Before replacing the lamp, disconnect the appliance from the power supply.
- Only use lamps with the same specifications.

2.7 Service

- To repair the appliance contact an Authorised Service Centre.
- Use original spare parts only.

2.8 Disposal



WARNING!

Risk of injury or suffocation.

- Disconnect the appliance from the mains supply.
- Cut off the mains electrical cable close to the appliance and dispose of it.
- Remove the door catch to prevent children or pets from becoming trapped in the appliance.

3. PRODUCT DESCRIPTION

3.1 General overview

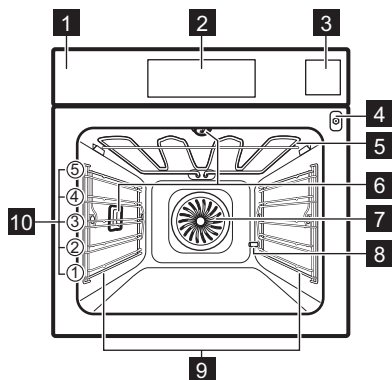

- 1 Control panel
- 2 Electronic programmer
- 3 Water drawer
- 4 Socket for the core temperature sensor
- 5 Heating element
- 6 Lamp
- 7 Fan
- 8 Descaling pipe outlet
- 9 Shelf support, removable
- 10 Shelf positions

3.2 Accessories

Wire shelf

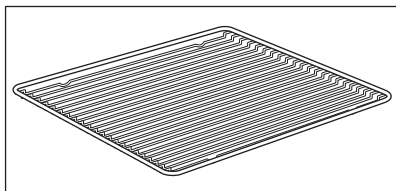

For cookware, cake tins, roasts.

Baking tray

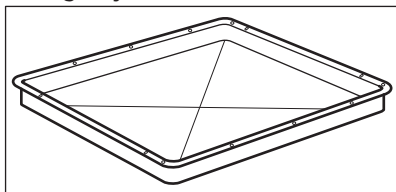

For cakes and biscuits.

Grill- / Roasting pan

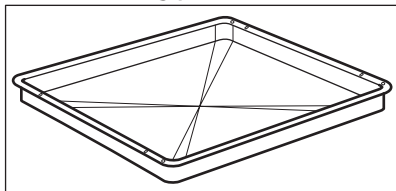

To bake and roast or as a pan to collect fat.

Food Sensor

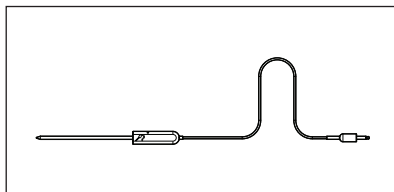

To measure the temperature inside the food.

Steam set

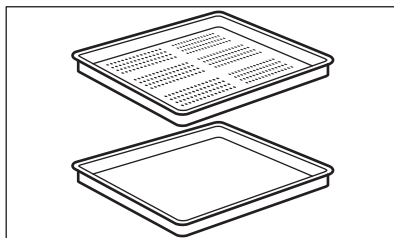

One unperforated and one perforated food container.

The steam set drains the condensing water away from the food during steam cooking. Use it to prepare food that should not be in the water during the cooking e.g. vegetables, pieces of fish,





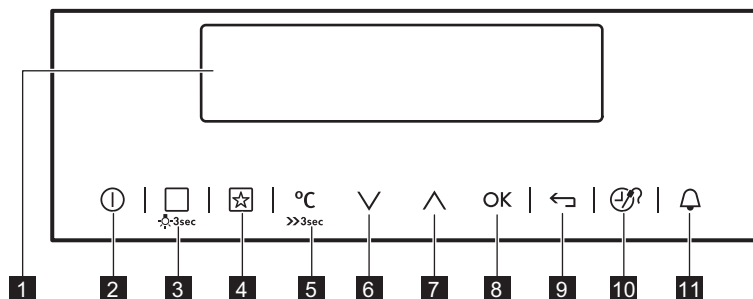

chicken breast. The set is not suitable for food that needs to soak in the water e.g. rice, polenta, pasta.





4. CONTROL PANEL

4.1 Electronic programmer



Use the sensor fields to operate the appliance.

Sensor field	Function	Comment
1	-	Display Shows the current settings of the appliance.
2	 ON / OFF	To activate and deactivate the appliance.
3	 Heating Functions or VarioGuide	Touch the sensor field once to choose a heating function or the menu: VarioGuide. Touch the sensor field again to switch between the menus: Heating Functions, VarioGuide. To activate or deactivate the light, touch the field for 3 seconds. You can activate the light also when the appliance is deactivated.
4	 Favourites	To save and access your favourite programmes.
5	 Temperature selection	To set the temperature or show the current temperature in the appliance. Touch the field for 3 seconds to activate or deactivate the function: Fast Heat Up.
6	 Down key	To move down in the menu.
7	 Up key	To move up in the menu.





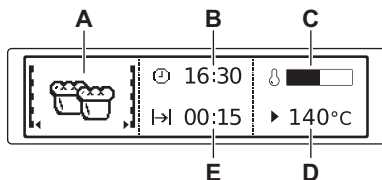





Sensor field	Function	Comment
8 	OK	To confirm the selection or setting.
9 	Back key	To go back one level in the menu. To show the main menu, touch the field for 3 seconds.
10 	Time and additional functions	To set different functions. When a heating function operates, touch the sensor field to set the timer or the functions: Function Lock, Favourites, Heat + Hold, Set + Go. You can also change the settings of the core temperature sensor.
11 	Minute Minder	To set the function: Minute Minder.



4.2 Display



- A. Heating function
- B. Time of day
- C. Heat-up indicator
- D. Temperature
- E. Duration time or end time of a function

Other indicators of the display:

Symbol	Function	Function
	Minute Minder	The function operates.
	Time of day	The display shows the current time.
	Duration	The display shows the necessary time for cooking.
	End Time	The display shows when the cooking time is complete.
	Temperature	The display shows the temperature.
	Time Indication	The display shows how long the heating function operates. Press  and  at the same time to reset the time.
	Calculation	The appliance calculates the time for cooking.
	Heat-up Indicator	The display shows the temperature in the appliance.

Symbol		Function
	Fast Heat Up Indicator	The function is active. It decreases the heat up time.
	Weight Automatic	The display shows that the automatic weight system is active or that weight can be changed.
	Heat + Hold	The function is active.

5. BEFORE FIRST USE



WARNING!

Refer to Safety chapters.

5.1 Initial Cleaning

Remove all accessories and removable shelf supports from the oven.



Refer to "Care and cleaning" chapter.

Clean the oven and the accessories before first use.

Put the accessories and the removable shelf supports back to their initial position.

5.2 First Connection

When you connect the appliance to the mains or after the power cut, you have to

set the language, the display contrast, the display brightness and the time of the day.

1. Press \wedge or \vee to set the value.
2. Press **OK** to confirm.

5.3 Setting the water hardness

The table below shows the water hardness range (dH) with the corresponding Calcium deposit and the quality of the water.



Water hardness		Calcium deposit (mmol/l)	Calcium deposit (mg/l)	Water classification
Class	dH			
1	0 - 7	0 - 1.3	0 - 50	Soft
2	7 - 14	1.3 - 2.5	50 - 100	Moderately hard
3	14 - 21	2.5 - 3.8	100 - 150	Hard
4	over 21	over 3.8	over 150	Very hard



When the water hardness exceeds the values in the table, fill the water drawer with bottled water.

1. Take the 4 colour change strip supplied with the steam set in the oven.
2. Put all the reaction zones of the strip into the water for approximately 1 second.

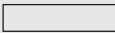
Do not put the strip into the running water.

3. Shake the strip to remove the excess of the water.
4. Wait 1 minute and check the water hardness with the table below. The colours of the reaction zones continue to change. Do not check the water hardness later than 1 minute after test.
5. Set the water hardness: menu: Basic Settings.

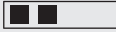
Test strip	Water hardness
	1
	

Test strip	Water hardness
	2
	3
	4

You can change the water hardness in the menu: Basic Settings / Water hardness.

6. DAILY USE



WARNING!







Refer to Safety chapters.

6.1 Navigating the menus

1. Activate the appliance.
2. Press ∇ or \blacktriangle to select the menu option.

6.2 The menus in overview

Main menu

Sym- bol	Menu item	Application
	Heating Functions	Contains a list of heating functions.
	SousVide Cooking	Contains a heating function and a list of automatic programmes.
	Recipes	Contains a list of automatic programmes.
	Favourites	Contains a list of favourite cooking programmes created by the user.
	Cleaning	Contains a list of cleaning programmes.
	Basic Settings	Used to set the appliance configuration.
	Specials	Contains a list of additional heating functions.

3. Press **OK** to move to the submenu or accept the setting.



















At each point you can go back to the main menu with



Symbol	Menu item	Application
	VarioGuide	Contains recommended oven settings for a wide choice of dishes. Select a dish and start the cooking process. The temperature and time are only guidelines for a better result and can be adjusted. They depend on the recipes and the quality and quantity of the used ingredients.



Submenu for: Basic Settings

Symbol	Submenu	Description
	Set Time of Day	Sets the current time on the clock.
	Time Indication	When ON, the display shows the current time when you deactivate the appliance.
	Fast Heat Up	When ON, the function decreases the heat-up time.
	Set + Go	To set a function and activate it later with a press of any symbol on the control panel.
	Heat + Hold	Keeps the prepared food warm for 30 minutes after a cooking cycle finished.
	Time Extension	Activates and deactivates the time extension function.
	Display Contrast	Adjusts the display contrast by degrees.
	Display Brightness	Adjusts the display brightness by degrees.
	Set Language	Sets the language for the display.
	Buzzer Volume	Adjusts the volume of press-tones and signals by degrees.
	Key Tones	Activates and deactivates the tone of the touch fields. It is not possible to deactivate the tone of the ON / OFF touch field.
	Alarm/Error Tones	Activates and deactivates the alarm tones.
	Water hardness	To sets the water hardness level (1 - 4).
	DEMO mode	Activation / deactivation code: 2468
	Service	Shows the software version and configuration.
	Factory Settings	Resets all settings to factory settings.





6.3 Submenu for: SousVide Cooking

This technique has its start in the Sous-vide technology, which in French means



"under vacuum". The name refers to a method of cooking in vacuum sealed plastic pouches at low temperatures.









Symbol	Menu item	Description
	SousVide Cooking	Uses the steam for cooking meat, fish, sea-food, vegetables and fruits. Set the temperature 50 °C - 95 °C.
	SousVide Recipes	Contains a list of automatic programmes.
	SousVide VarioGuide	Contains recommended oven settings for a wide choice of dishes. Select a dish and start the cooking process. The temperature and time are only guidelines for a better result and can be adjusted. They depend on the recipes and the quality and quantity of the used ingredients.

6.4 Submenu for: Cleaning



Symbol	Menu item	Description
	Steam Cleaning	Procedure for cleaning the appliance when it is slightly soiled and not burned several times.
	Descaling	Procedure for cleaning the steam generation circuit from residual limestone.
	Rinsing	Procedure for rinsing and cleaning the steam generation circuit after frequent use of the steam functions.
	Steam Cleaning Plus	Procedure for cleaning stubborn dirt with the support of an oven cleaner.

6.5 Heating Functions

Heating function	Application
 True Fan Cooking	To bake on up to three shelf positions at the same time and to dry food. Set the temperature 20 - 40 °C lower than for the function: Conventional Cooking.
 Pizza Setting	To bake food on one shelf position for a more intensive browning and a crispy bottom. Set the temperature 20 - 40 °C lower than for the function: Conventional Cooking.











Heating function	Application
 <p>Conventional Cooking (Top / Bottom Heat)</p>	To bake and roast food on one shelf position.
 <p>Frozen Foods</p>	To make convenience food like e.g. french fries, potato wedges or spring rolls crispy.
 <p>Grill</p>	To grill flat food and to toast bread.
 <p>Turbo Grilling</p>	To roast larger meat joints or poultry with bones on one shelf position. Also to make gratins and to brown.
 <p>Bottom Heat</p>	To bake cakes with crispy bottom and to preserve food.
 <p>Moist Fan Baking</p>	To bake breads, cakes and cookies. To save energy during cooking. This function must be used in accordance with the Moist Fan Baking table in order to achieve the desired cooking result. To get more information about the recommended settings, refer to the Hints and Tips chapter, Moist Fan Baking table. This function was used to define the energy efficiency class acc. to EN 60350-1.
 <p>Humidity Cooking</p>	You can choose between three manual cooking functions with different levels of humidity. These functions combine steam and hot air. They cover cooking with different levels of steam.
 <p>Full Steam</p>	For vegetables, fish, potatoes, rice, pasta or special side-dishes.

Submenu for: Humidity Cooking

Heating function	Application
 <p>Humidity Low</p>	The function is suitable for meat, poultry, oven dishes and casseroles. Thanks to the combination of steam and heat, meat gets a tender and juicy texture along with a crusty surface.
 <p>Humidity Medium</p>	The function is suitable for cooking stewed and braised meat as well as bread and sweet yeast dough. Due to the combination of steam and heat the meat gets a juicy and tender texture and yeast dough bakeries get a crispy and shiny surface.
 <p>Humidity High</p>	The function is suitable for cooking delicate dishes like custards, flans, terrines and fish.

-  The lamp may automatically deactivate at a temperature below 60 °C during some oven functions.

6.6 Specials

Heating function	Application
 Keep Warm	To keep food warm.
 Plate Warming	To preheat plates for serving.
 Preserving	To make vegetable preserves such as pickles.
 Drying	To dry sliced fruit (e.g. apples, plums, peaches) and vegetables (e.g. tomatoes, zucchini, mushrooms).
 Yogurt Function	Use this function to prepare yoghurt. The lamp in this function is off.
 Dough Proving	Steam humidifying action improves and speeds up the dough proving, prevents surface drying and keeps the dough elastic.
 Slow Cooking	To prepare tender, succulent roasts.
 Bread Baking	Use this function to prepare bread and bread rolls with a very good professional-like result in terms of crispiness, colour and crust gloss.
 Steam Regenerating	Food reheating with steam prevents surface drying. Heat is distributed in a gentle and even way, which allows to recover taste and aroma of food as just prepared. This function can be used to reheat food directly on a plate. You can reheat more than one plate at the same time, using different shelf positions.
 Defrost	This function can be used for defrosting frozen foods, such as vegetables and fruits. The defrosting time depends on the amount and size of the frozen food.





6.7 Submenu for: VarioGuide

Food Category: Fish/Seafood





Dish	
Fish	Fish, baked
	Fish Fingers
	Fish fillet, thin
	Fish fillet, thick
	Fish fillet, frozen
	Whole small Fish
	Whole Fish, steamed
	Whole small Fish, grilled
	Whole Fish, grilled
	Whole Fish, grilled 
	Trout
Salmon	Salmon fillet
	Whole Salmon
Prawns	Prawns, fresh
	Prawns, frozen
Mussels	-









Food Category: Poultry



Dish	
Boned Poultry	-
Boned Poultry 	-

Dish	
Chicken	Chicken Wings, fresh
	Chicken Wings, frozen
	Chicken Legs, fresh
	Chicken Legs, frozen
	Chicken Breast, poached
	Chicken, 2 half
	Whole Chicken 
	Whole Duck 
Whole Goose 	-
Whole Turkey 	-

Food Category: Meat

Dish	
Beef	Prime Boiled Beef
	Braised meat 
	Meat Loaf
Beef	Braised meat 
	Meat Loaf
Roast Beef	Rare
	Rare 
	Medium
	Medium 
	Well Done
Well Done 	

Dish	
Scandinavian Beef	Rare 
	Medium 
	Well Done 
Pork	Chipolatas
	Spare Ribs
	Pork Knuckle, pre-cooked
	Pork Joint
	Loin of Pork
	Loin of Pork 
	Loin of Pork, smoked
	Loin of Pork, poached
	Pork Neck
	Pork Shoulder
	Roast Pork 
Cooked Ham	
Veal	Veal Knuckle
	Loin of Veal
	Roast Veal 
Lamb	Leg of Lamb
	Roast Lamb 
	Saddle of Lamb
	Lamb Joint, medium
	Lamb Joint, medium 

Dish	
Game	Hare <ul style="list-style-type: none"> • Leg of Hare • Saddle of Hare • Saddle of Hare 
	Venison <ul style="list-style-type: none"> • Haunch of Venison • Saddle of Venison
	Roast Game 
	Loin of Game 

Food Category: Oven Dishes

Dish	
Lasagne	-
Lasagne/Cannelloni, frozen	-
Pasta	-
Potato Gratin	-
Vegetables au Gratin	-
Sweet Dishes	-

Food Category: Pizza/Quiche

Dish	
Pizza	Pizza, thin
	Pizza, extra topping
	Pizza, frozen
	Pizza American, frozen
	Pizza, chilled
	Pizza Snacks, frozen
Baguettes au Gratin	-
Tarte Flambée	-
Swiss Tarte, savoury	-

Dish	
Quiche Lorraine	-
Savory Flan	-

Food Category: Cake/Pastry

Dish	
Ring Cake	-
Apple Cake, covered	-
Sponge Cake	-
Apple Pie	-
Cheese Cake, Tin	-
Brioche	-
Madeira Cake	-
Tarte	-
Swiss Tarte, sweet	-
Almond Cake	-
Muffins	-
Pastry	-
Pastry Stripes	-
Cream Puffs	-
Puff Pastry	-
Eclairs	-
Macaroons	-
Short Pastry Biscuits	-
Christmas Stollen	-
Apple Strudel, frozen	-
Cake on Tray	Sponge Dough Yeast Dough
Cheese Cake, Tray	-
Brownies	-
Swiss Roll	-

Dish	
Yeast Cake	-
Crumble Cake	-
Sugar Cake	-
Flan Base	Short Pastry Flan Base Sponge Mixture Flan Base
Fruit Flan	Short Pastry Fruit Flan Sponge Mixture Fruit Flan Yeast Dough

Food Category: Bread/Rolls

Dish	
Rolls	Rolls Rolls, pre-baked Rolls, frozen
Ciabatta	-
Baguette	Baguette, pre-baked Baguette, frozen
Bread	Bread Crown White Bread Yeast Plait Brown Bread Rye Bread Wholegrain Bread Unleavened Bread Bread/Rolls, frozen

Food Category: Vegetables

Dish	
Broccoli, Florets	-

Dish	
Broccoli, whole	-
Cauliflower, Florets	-
Cauliflower, whole	-
Carrots	-
Courgette Slices	-
Asparagus, green	-
Asparagus, white	-
Pepper Stripes	-
Spinach, fresh	-
Leek Rings	-
Green Beans	-
Mushroom Slices	-
Peeling Tomatoes	-
Brussels Sprouts	-
Celery, cubed	-
Peas	-
Eggplant	-
Fennel	-
Artichokes	-
Beetroot	-
Black Salsify	-
Cabbage Turnip Stripes	-
White Haricot Beans	-
Savoy Cabbage	-

Food Category: Custards/Terrines

Dish	
Egg Custard	-
Flan Caramel	-
Terrine	-

Dish	
Eggs	Eggs, soft boiled
	Eggs, medium boiled
	Eggs, hard boiled
	Eggs, baked

Food Category: Side Dishes

Dish	
French Fries, thin	-
French Fries, thick	-
French Fries, frozen	-
Croquettes	-
Wedges	-
Hash Browns	-
Boiled Potatoes, quartered	-
Boiled Potatoes	-
Potatoes in their jacket	-
Potato Dumplings	-
Bread Dumplings	-
Yeast Dumplings, salty	-
Yeast Dumplings, sweet	-
Rice	-
Tagliatelle, fresh	-
Polenta	-



When it is necessary to change the weight or the core temperature of the dish, use \wedge or \vee to set the new values.

6.8 Submenu for: SousVide VarioGuide

Food category	Dish
Fish/Seafood	Sea bream fillet
	Sea Bass fillet
	Cod Fish
	Trout fillet
	Salmon fillet
	Scallops
	Mussels with shell
	Prawns without shell
	Octopus
Poultry	Chicken Breast, boneless
	Duck Breast, boneless
	Turkey Breast, boneless
Meat	Beef <ul style="list-style-type: none"> • Beef fillet, medium • Beef fillet, well done
	Lamb <ul style="list-style-type: none"> • Lamb, medium • Lamb, well done
	Game <ul style="list-style-type: none"> • Wild Boar • Rabbit, boneless

Food category	Dish
Vegetables	Carrots
	Courgette Slices
	Asparagus, green
	Asparagus, white
	Pepper Stripes
	Leek Rings
	Celery root
	Celery
	Eggplant
	Fennel
	Artichoke Hearts
	Potatoes
	Pumpkin
Fruits	Apples
	Pears
	Peaches
	Nectarines
	Plums
	Pineapple
Mangos	

6.9 Activating a heating function

1. Activate the appliance.
2. Select the menu: Heating Functions.
3. Press **OK** to confirm.
4. Select a heating function.
5. Press **OK** to confirm.
6. Set the temperature.
7. Press **OK** to confirm.



In case the default settings are not changed, the appliance starts automatically.

6.10 Water drawer

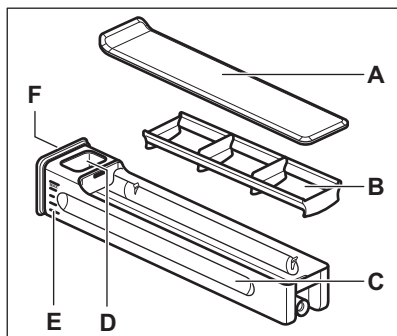

- A. Lid
- B. Wave-breaker
- C. Drawer body
- D. Water-filling hole
- E. Scale
- F. Front button

You can remove the water drawer from the oven. Push it gently on the front button. After you push the water drawer, it will self-extract from the oven.

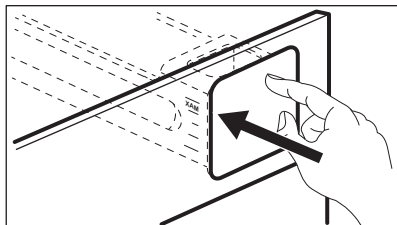

You can fill the water drawer in two ways:

- leave the water drawer inside the oven and fill it by means of a water jar,
- detach the water drawer from the oven and fill it from a water tap.

When you fill the water drawer from the water tap, carry the drawer in the horizontal position in order to avoid water spilling.

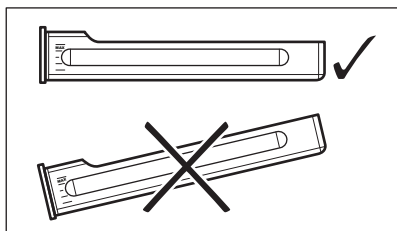

When you fill the water drawer, insert it in the same position. Push the front button until the water drawer is inside the oven.

Empty the water drawer after each use.



CAUTION!

Keep the water drawer away from hot surfaces.

6.11 Steam cooking

The water drawer cover is in the control panel.



WARNING!

Use only cold tap water. Do not use filtered (demineralised) or distilled water. Do not use other liquids. Do not put flammable or alcoholic liquids into the water drawer.

1. Press the cover of the water drawer to open it and extract it from the appliance.
2. Fill the water drawer with cold water to the maximum level (around 950 ml). The water supply is sufficient for approximately 50 minutes. Use the scale on the water drawer.
3. Push the water drawer to its initial position.



Wipe the wet water drawer with a soft cloth before you insert it in the appliance.

4. Turn on the appliance.
5. Set a steam heating function and the temperature.
6. If necessary, set the function: Duration \rightarrow | or: End Time \rightarrow |.

The steam appears after approximately 2 minutes. When the appliance reaches the set temperature, the signal sounds. When the water drawer is running out of water, the signal sounds and the water drawer needs to be refilled as described above.

The signal sounds at the end of the cooking time.

7. Turn off the appliance.

8. Empty the water drawer after the steam cooking is completed.



CAUTION!

The appliance is hot.
There is a risk of burns.
Be careful when you empty the water drawer.

9. After Steam Cooking steam can condensate on the bottom of the cavity. Always dry the bottom of the cavity when the appliance is cool.

Let the appliance dry fully with the door open. To speed up the drying you can close the door and heat up the appliance with function: True Fan Cooking at temperature 150°C for approximately 15 minutes.



At the end of a steam cooking, the cooling fan runs faster to remove the steam.

6.12 SousVide Cooking

- With no evaporative losses of flavour volatile and moisture, food keeps its full aroma.
- Tender texture of meat and fish.
- Food keeps all minerals and vitamins.
- Less spices are necessary as food keeps its natural flavour.
- Better workflow as it is not necessary to prepare and serve food at the same time and place.
- Low cooking temperature minimizes the risk of overcooking.
- Portioning of the food makes it easy to hold.

Preparing the food

1. Clean and cut the ingredients.
2. Season the ingredients.
3. Fill the ingredients in suitable vacuum bags.
4. Vacuum seal the bag to make sure that you remove as much air as possible.
5. Cold storage of the bags is mandatory in case the cooking procedure is not done immediately.
6. Continue with the function SousVide Cooking following applicable cooking table indications for the considered type of food or the assisted cooking recipes.

7. Open the pouch and serve.
8. Optionally finish the food with a final searing or grilling e.g. for meat to achieve a nice crust and the typical roast flavour.

Activating a function: SousVide Cooking

1. Activate the appliance.
2. Select the menu: SousVide Cooking.
3. Press **OK** to confirm.
4. Set the function: SousVide Cooking.
5. Press **OK** to confirm.
6. Set the temperature.
7. Press **OK** to confirm.



Cooking with this function causes residual water on the vacuum bags and in the cavity. After the cooking process open the door carefully to avoid the water dropping on the furniture. Use a plate and a towel to take out the vacuum bags. Dry out the door, the water drop collector in the bottom and the cavity with a soft cloth or a sponge. Let the appliance dry fully with the door open. To speed up the drying you can heat up the appliance with hot air at temperature 150 °C for approximately 15 minutes.

6.13 Heat-up indicator

When you activate a heating function, the bar on the display comes on. The bar shows that the temperature increases. When temperature is reached the buzzer sounds 3 times and the bar flashes and then disappears.

6.14 Fast Heat Up Indicator

This function decreases the heat-up time.



Do not put food in the oven when the Fast heat up function operates.







To activate the function, hold $\gg^{\circ\text{C}}$ for 3 seconds. The heat-up indicator alternates.

6.15 Residual heat

When you turn off the oven, the display shows the residual heat. You can use the heat to keep the food warm.

7. CLOCK FUNCTIONS

7.1 Clock functions table

Clock function	Application
 Minute Minder	To set a countdown (max. 2 h 30 min). This function has no effect on the operation of the appliance. You can also activate it when the appliance is deactivated. Use  to activate the function. Press  or  to set the minutes and OK to start.
 Duration	To set the length of an operation (max. 23 h 59 min).
 End Time	To set the switch-off time for a heating function (max. 23 h 59 min).

If you set the time for a clock function, the time starts to count down after 5 seconds.





If you use the clock functions: Duration, End Time, the appliance deactivates the heating elements after 90 % of the set time. The appliance uses the residual heat to continue the cooking process until the time ends (3 - 20 minutes).

7.2 Setting the clock functions



Before you use the functions: Duration, End Time, you must set a heating function and temperature first. The appliance deactivates automatically. You can use the functions: Duration and End Time at the same time if you want to automatically activate and deactivate the appliance on a given time later. The functions: Duration and End Time do not work when you use the core temperature sensor.

1. Set a heating function.
2. Press  again and again until the display shows the necessary clock function and the related symbol.
3. Press  or  to set the necessary time.
4. Press **OK** to confirm.

When the time ends, an acoustic signal sounds. The appliance deactivates. The display shows a message.

5. Press any symbol to stop the signal.

7.3 Heat + Hold

Conditions for the function:

- The set temperature is more than 80 °C.
- The function: Duration is set.

The function: Heat + Hold keeps prepared food warm at 80 °C for 30 minutes. It activates after the baking or roasting procedure ends.

You can activate or deactivate the function in the menu: Basic Settings.

1. Activate the appliance.
2. Select the heating function.
3. Set the temperature above 80 °C.
4. Press  again and again until the display shows: Heat + Hold.

5. Press **OK** to confirm.

When the function ends, an acoustic signal sounds.



The function stays on if you change the heating functions.

7.4 Time Extension

The function: Time Extension makes the heating function continue after the end of Duration.



Not applicable to heating functions with the core temperature sensor.

1. When the cooking time ends, an acoustic signal sounds. Press any symbol.
The display shows the message.
2. Press  to activate or  to cancel.
3. Set the length of the function.
4. Press **OK**.

8. AUTOMATIC PROGRAMMES



WARNING!

Refer to Safety chapters.

8.1 Recipes online



You can find the recipes for the automatic programmes specified for this appliance on our website. To find the proper Recipe Book check the PNC number on the rating plate on the front frame of the appliance cavity.

8.2 Recipes with Recipe Automatic

This appliance has a set of recipes you can use. The recipes are fixed and you cannot change them.

1. Activate the appliance.
2. Select the menu: Recipes. Press **OK** to confirm.
3. Select the category and dish. Press **OK** to confirm.
4. Select a recipe. Press **OK** to confirm.

9. USING THE ACCESSORIES



WARNING!

Refer to Safety chapters.

9.1 Food sensor

The food sensor measures temperature inside the food. When the food is at the set temperature, the appliance deactivates.

There are two temperatures to be set:

- the oven temperature (minimum 120 °C),
- the food core temperature.



CAUTION!

Use only the food sensor supplied and the original replacement parts.

Directions for the best results:

- Ingredients should be at room temperature.
- Food sensor cannot be used for liquid dishes.
- During cooking the food sensor must remain in the dish and the plug in the socket.
- Use recommended food core temperature settings. Refer to "Hints and tips" chapter.

i The appliance calculates an approximate end of cooking time. It depends on the quantity of food, the set oven function and temperature.

Food categories: meat, poultry and fish

1. Activate the appliance.
2. Insert the tip of the food sensor into the centre of meat or fish, in the thickest part if possible. Make sure that at least 3/4 of the food sensor is inside of the dish.
3. Put the plug of the food sensor into the socket located in the front frame of the appliance.

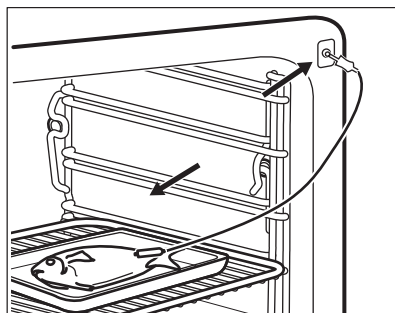
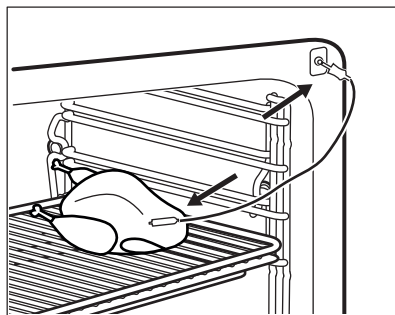

The display shows the food sensor symbol.

4. Press \blacktriangle or \blacktriangledown in less than 5 seconds to set the food core temperature.
5. Set a heating function and, if necessary, the oven temperature.
6. To change the food core temperature, press Ⓢ .

When the dish reaches the set temperature, an acoustic signal sounds. The appliance deactivates automatically.

7. Touch any symbol to stop the signal.
8. Remove the food sensor plug from the socket and remove the dish from the appliance.



WARNING!

There is a risk of burns as the food sensor becomes hot. Be careful when you unplug it and remove it from the food.

Food category: casserole

1. Activate the appliance.
2. Place half of the ingredients in a baking dish.

3. Insert the tip of the food sensor exactly in the centre of the casserole. The food sensor should be stabilized in one place during baking. Use a solid ingredient to achieve that. Use the rim of the baking dish to support the silicone handle of the food sensor. The tip of the food sensor should not touch the bottom of a baking dish.

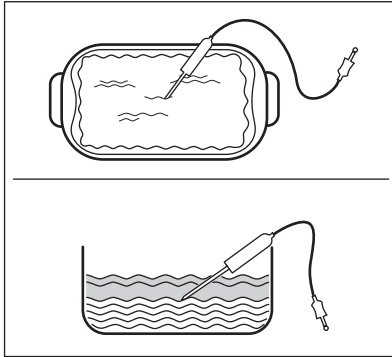

4. Cover the food sensor with the remaining ingredients.
5. Put the plug of the food sensor into the socket located in the front frame of the appliance.

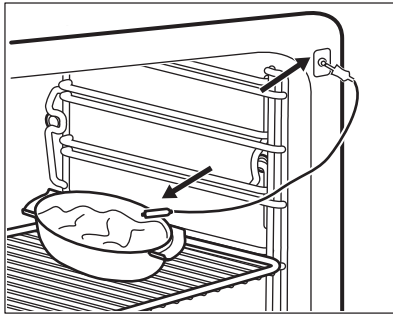

The display shows the food sensor symbol.

6. Press \wedge or \vee in less than 5 seconds to set the food core temperature.
7. Set a heating function and, if necessary, the oven temperature.
8. To change the food core temperature, press ⌚ .

When the dish is at the set temperature, an acoustic signal sounds. The appliance deactivates automatically.

9. Touch any symbol to stop the signal.
10. Remove the food sensor plug from the socket and remove the dish from the appliance.



WARNING!

There is a risk of burns as the food sensor becomes hot. Be careful when you unplug it and remove it from the food.

9.2 Inserting the accessories

Wire shelf:

Push the shelf between the guide bars of the shelf support and make sure that the feet point down.

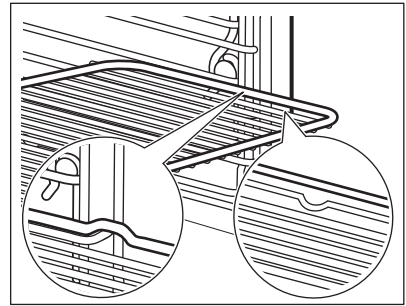

Baking tray / Deep pan:

Push the baking tray / deep pan between the guide bars of the shelf support.

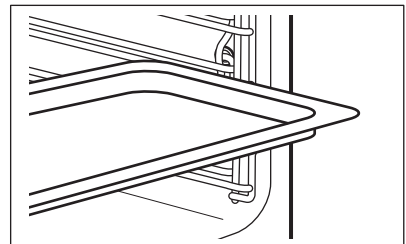

Wire shelf and baking tray / deep pan together:

Push the baking tray / deep pan between the guide bars of the shelf support and the wire shelf on the guide bars above.

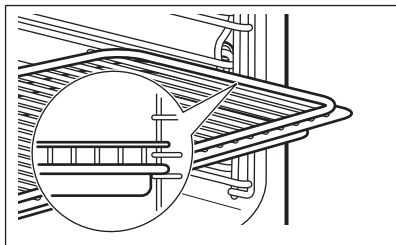

Small indentation at the top increase safety. The indentations are also anti-tip devices. The high rim around the shelf prevents cookware from slipping off the shelf.

10. ADDITIONAL FUNCTIONS

10.1 Favourites

You can save your favourite settings, such as duration, temperature or heating function. They are available in the menu: Favourites. You can save 20 programmes.

Saving a programme

1. Activate the appliance.
2. Set a heating function or an automatic programme.
3. Touch again and again until the display shows: SAVE.
4. Press **OK** to confirm. The display shows the first free memory position.
5. Press **OK** to confirm.
6. Enter the name of the programme. The first letter flashes.
7. Touch or to change the letter.
8. Press **OK**. The next letter flashes.
9. Do step 7 again as necessary.
10. Press and hold **OK** to save. You can overwrite a memory position. When the display shows the first free memory position, touch or and press **OK** to overwrite an existing programme.

You can change the name of a programme in the menu: Edit Programme Name.

Activating the programme

1. Activate the appliance.

2. Select the menu: Favourites.
3. Press **OK** to confirm.
4. Select your favourite programme name.
5. Press **OK** to confirm.

Press to go directly to menu: Favourites. You can also use it when the appliance is deactivated.

10.2 Using the Child Lock

When the Child Lock is on, the appliance cannot be activated accidentally.

1. Touch to activate the display.
2. Touch and at the same time until the display shows a message. To deactivate the Child Lock function repeat step 2.

10.3 Function Lock

This function prevents an accidental change of the heating function. You can activate it only when the appliance operates.

1. Activate the appliance.
2. Set a heating function or setting.
3. Press again and again until the display shows: Function Lock.
4. Press **OK** to confirm.



To deactivate the function, press . The display shows a message. Press again and then **OK** to confirm.



When you deactivate the appliance, the function also deactivates.

10.4 Set + Go

The function lets you set a heating function (or a programme) and use it later with one press of any symbol.

1. Activate the appliance.
2. Set a heating function.
3. Press  again and again until the display shows: Duration.
4. Set the time.
5. Press  again and again until the display shows: Set + Go.
6. Press **OK** to confirm.

Press any symbol (except for ) to start the function: Set + Go. The set heating function starts.

When the heating function ends, an acoustic signal sounds.



- Function Lock is on when the heating function operates.
- The menu: Basic Settings lets you activate and deactivate the function: Set + Go.

10.5 Automatic Switch-off

For safety reasons the appliance turns off automatically after some time if a heating function operates and you do not change any settings.

Temperature (°C)	Switch-off time (h)
30 - 115	12.5

Temperature (°C)	Switch-off time (h)
120 - 195	8.5
200 - 230	5.5



The Automatic switch-off does not work with the functions: Light, Food Sensor, Duration, End Time.

10.6 Brightness of the display

There are two modes of display brightness:

- Night brightness - when the appliance is deactivated, the brightness of the display is lower between 10 PM and 6 AM.
- Day brightness:
 - when the appliance is activated.
 - if you touch a symbol during the night brightness (apart from ON / OFF), the display goes back to the day brightness mode for the next 10 seconds.
 - if the appliance is deactivated and you set the function: Minute Minder. When the function ends, the display goes back to the night brightness.

10.7 Cooling fan

When the oven operates, the cooling fan turns on automatically to keep the surfaces of the oven cool. If you turn off the oven, the cooling fan can continue to operate until the oven cools down.

11. HINTS AND TIPS



WARNING!

Refer to Safety chapters.



The temperature and baking times in the tables are guidelines only. They depend on the recipes and the quality and quantity of the ingredients used.

11.1 Inner side of the door

On the inner side of the door you can find:

- the numbers of the shelf positions.
- information about the heating functions, recommended shelf positions and temperatures for dishes.

11.2 Advice for special heating functions of the oven

Keep Warm

The function allows you to keep food warm. The temperature is set automatically to 80 °C.

Plate Warming

The function allows you to warm plates and dishes before serving. The temperature is set automatically to 70 °C.

Place plates and dishes in stacks evenly on the wire shelf. Use the first shelf position. After half of the warming time switch their places.

Dough Proving

The function allows you to rise yeast dough. Put the dough into a big dish. Use the first shelf position. Set function: Dough Proving and the cooking time.

Defrost

Remove the food packaging and put the food on a plate. Do not cover the food, as it can extend the defrosting time. Use the first shelf position.

11.3 SousVide Cooking

This function uses lower cooking temperatures than normal cooking.

SousVide Cooking Recommendations

Use high quality and fresh raw food. Always clean the food before cooking. Be careful when using raw eggs.

Low temperatures are suitable only for the types of food that can be eaten raw.

Beef

Food	Thickness of food	Amount of food for 4 persons (g)	Temperature (°C)	Time (min)	Shelf position
Beef fillet medium	4 cm	800	60	110 - 120	3

Do not cook the food for a long time when you are using the temperature below 60 °C.

Boil ingredients containing alcohol before vacuum packing.

Put the vacuum bags on the grid side by side.

You can keep the cooked food in the fridge for 2 – 3 days. Cool down the food quickly (by using ice bath).

Do not use this function for reheating food leftovers.

Vacuum Packing

Use only the vacuum bags and chamber vacuum sealer recommended for sous-vide cooking. Only this type of vacuum sealer can vacuum pack liquids.

Do not reuse vacuum bags.

For faster and better results set the maximum vacuum degree.

To guarantee a safe closing of the vacuum bag, make sure that the area subject to the seal is clean.

Make sure that the edges of the inner side of the vacuum bag are clean, before sealing it.

11.4 SousVide Cooking: Meat

- Look at the tables to prevent undercooking. Do not use meat portions of a larger thickness than the tables show.
- The cooking times in the tables are the minimum necessary times. The cooking time can be increased in accordance to personal preferences.
- Use only boneless meat to avoid damages to the vacuum bags.
- For the poultry fillets to taste better, fry them on the skin side before and after vacuum packing.

Food	Thickness of food	Amount of food for 4 persons (g)	Temperature (°C)	Time (min)	Shelf position
Beef fillet well done	4 cm	800	65	90 - 100	3
Veal fillet medium	4 cm	800	60	110 - 120	3
Veal fillet well done	4 cm	800	65	90 - 100	3

Lamb / Game

Food	Thickness of food	Amount of food for 4 persons (g)	Temperature (°C)	Time (min)	Shelf position
Lamb rare	3 cm	600 - 650	60	180 - 190	3
Lamb medium	3 cm	600 - 650	65	105 - 115	3
Boar	3 cm	600 - 650	90	60 - 70	3
Rabbit boneless	1.5 cm	600 - 650	70	50 - 60	3

Poultry

Food	Thickness of food	Amount of food for 4 persons (g)	Temperature (°C)	Time (min)	Shelf position
Chicken breast boneless	3 cm	750	70	70 - 80	3
Duck breast boneless	2 cm	900	60	140 - 160	3
Turkey breast boneless	2 cm	800	70	75 - 85	3

11.5 SousVide Cooking: Fish and seafood

- Look at the table to prevent undercooking. Do not use fish portions of a larger thickness than the table show.
- Dry the fish fillets with a paper towel before you put them in a vacuum bag.
- Add a cup of water in the vacuum bag when you cook the mussels.

Food	Thickness of food	Amount of food for 4 persons (g)	Temperature (°C)	Time (min)	Shelf position
Sea bream fillet	4 fillets 1 cm	500	70	25	3
Sea bass fillet	4 fillets 1 cm	500	70	25	3
Cod fish	2 fillets 2 cm	650	65	70 - 75	3
Scallops	big size	650	60	100 - 110	3
Mussels with shell		1000	95	20 - 25	3
Prawns without shell	big size	500	75	26 - 30	3
Octopus		1000	85	100 - 110	3
Trout fillet 1)	2 fillets 1.5 cm	650	65	55 - 65	3
Salmon fillet 1)	3 cm	800	65	100 - 110	3

1) To prevent protein leak soak the fish in a 10 % salt solution (100 g salt in 1 litre of water) for 30 min and dry with a paper towel before you put it in a vacuum bag.

11.6 SousVide Cooking: Vegetables

- Peel the vegetables where necessary.
- Some vegetables can change their colour when you peel them and cook in a vacuum packing. For better

results cook the food immediately after you prepare it.

- To keep the colour of the artichokes, put them in water with lemon juice, after you clean and cut them.

Food	Thickness of food	Amount of food for 4 persons (g)	Temperature (°C)	Time (min)	Shelf position
Asparagus green	whole	700 - 800	90	40 - 50	3
Asparagus white	whole	700 - 800	90	50 - 60	3
Courgette	slices of 1 cm	700 - 800	90	35 - 40	3
Leek	stripes or rings	600 - 700	95	40 - 45	3
Eggplant	slices of 1 cm	700 - 800	90	30 - 35	3
Pumpkin	pieces with thickness of 2 cm	700 - 800	90	25 - 30	3
Pepper	stripes or quarter	700 - 800	95	35 - 40	3

Food	Thickness of food	Amount of food for 4 persons (g)	Temperature (°C)	Time (min)	Shelf position
Celery	rings of 1 cm	700 - 800	95	40 - 45	3
Carrots	slices of 0.5 cm	700 - 800	95	35 - 45	3
Celery root	slices of 1 cm	700 - 800	95	45 - 50	3
Fennel	slices of 1 cm	700 - 800	95	35 - 45	3
Potatoes	slices of 1 cm	800 - 1000	95	35 - 45	3
Artichoke hearts	cut in quarter	400 - 600	95	45 - 55	3

11.7 SousVide Cooking: Fruits and sweets

- Peel the fruits, remove the seeds and cores where necessary

- To keep the colour of the apples and pears, put them in water with lemon juice, after you clean and cut them.
- For better results cook the food immediately after you prepare it.

Food	Thickness of food	Amount of food for 4 persons (g)	Temperature (°C)	Time (min)	Shelf position
Peach	cut in halves	4 fruits	90	20 - 25	3
Plum	cut in halves	600 g	90	10 - 15	3
Mango	cut in cubes of about 2 x 2 cm	2 fruits	90	10 - 15	3
Nectarine	cut in halves	4 fruits	90	20 - 25	3
Pineapple	slices 1 cm	600 g	90	20 - 25	3
Apple	cut in quarters	4 fruits	95	25 - 30	3
Pear	cut in halves	4 fruits	95	15 - 30	3
Vanilla creme	350 g in each bag	700 g	85	20 - 22	3

11.8 Full Steam



WARNING!

Be careful when you open the oven door when the function is activated. Steam can release.

The function is applicable for all types of food, fresh or frozen. You can use it to cook, warm, defrost, poach or blanch

vegetables, meat, fish, pasta, rice, sweet corn, semolina and eggs.

You can prepare a full meal in one operation. To correctly cook each dish, use those with cooking times which are almost the same. Fill the water drawer to the maximum level. Put the dishes into the correct cookware and then on the wire shelves. Adjust the distance between the cookware to let the steam circulate.

Sterilisation

- With this function you can sterilise containers (e.g. baby bottles).
- Put the clean containers in the middle of the shelf on the first shelf position. Make sure that the opening is down at a small angle.
- Fill the drawer with the maximum quantity of water and set the time to 40 minutes.

Vegetables

Food	Temperature (°C)	Time (min)	Shelf position
Artichokes	99	50 - 60	2
Auberginen	99	15 - 25	2
Cauliflower, whole	99	35 - 45	2
Cauliflower, florets	99	25 - 35	2
Broccoli, whole	99	30 - 40	2
Broccoli, florets ¹⁾	99	13 - 15	2
Mushroom slices	99	15 - 20	2
Peas	99	20 - 30	2
Fennel	99	25 - 35	2
Carrots	99	25 - 35	2
Kohlrabi, strips	99	25 - 35	2
Peppers, strips	99	15 - 20	2
Leeks, rings	99	20 - 30	2
Green beans	99	35 - 45	2
Lamb's lettuce, florets	99	20 - 25	2
Brussels sprouts	99	25 - 35	2
Beetroot	99	70 - 90	2
Black salsify	99	35 - 45	2
Celery, cubed	99	20 - 30	2
Asparagus, green	99	15 - 25	2
Asparagus, white	99	25 - 35	2
Spinach, fresh	99	15 - 20	2

Food	Temperature (°C)	Time (min)	Shelf position
Peeling tomatoes	99	10	2
White haricot beans	99	25 - 35	2
Savoy cabbage	99	20 - 25	2
Courgette, slices	99	15 - 25	2
Beans, blanched	99	20 - 25	2
Vegetables, blanched	99	15	2
Dried beans, soaked (water / beans ratio 2:1)	99	55 - 65	2
Snow peas (kaiser peppers)	99	20 - 30	2
Cabbage white or red, stripes	99	40 - 45	2
Pumpkin, cubes	99	15 - 25	2
Sauerkraut	99	60 - 90	2
Sweet potatoes	99	20 - 30	2
Tomatoes	99	15 - 25	2
Sweet corn on the cob	99	30 - 40	2

1) Preheat the oven for 5 minutes.

Side dishes / accompaniments

Food	Temperature (°C)	Time (min)	Shelf position
Yeast dumplings	99	25 - 35	2
Potato dumplings	99	35 - 45	2
Unpeeled potatoes, medium	99	45 - 55	2
Rice (water / rice ratio 1:1) ¹⁾	99	35 - 45	2
Boiled potatoes, quartered	99	35 - 45	2
Bread dumpling	99	35 - 45	2

Food	Temperature (°C)	Time (min)	Shelf position
Tagliatelle, fresh	99	15 - 25	2
Polenta (liquid ratio 3:1)	99	40 - 50	2
Bulgur (water / bulgur ratio 1:1)	99	25 - 35	2
Couscous (water / couscous ratio 1:1)	99	15 - 20	2
Spaetzle (german type of pasta)	99	25 - 30	2
Fragrant rice (water / rice ratio 1:1)	99	30 - 35	2
Lentils, red (water / lentils ratio 1:1)	99	20 - 30	2
Lentils, brown and green (water / lentils ratio 2:1)	99	55 - 60	2
Rice pudding (milk / rice ratio 2.5:1)	99	40 - 55	2
Semolina pudding (milk / semolina ratio 3.5:1)	99	20 - 25	2

1) The ratio of water to rice can change according to the type of rice.

Fruits

Food	Temperature (°C)	Time (min)	Shelf position
Apple slices	99	10 - 15	2
Hot berries	99	10 - 15	2
Fruit compote	99	20 - 25	2
Chocolate melting	99	10 - 20	2

Fish

Food	Temperature (°C)	Time (min)	Shelf position
Trout, approx. 250 g	85	20 - 30	2

Food	Temperature (°C)	Time (min)	Shelf position
Prawns, fresh	85	20 - 25	2
Prawns, frozen	85	30 - 40	2
Salmon fillets	85	20 - 30	2
Salmon trout, approx. 1000 g	85	40 - 45	2
Mussels	99	20 - 30	2
Flat fish fillet	80	15	2

Meat

Food	Temperature (°C)	Time (min)	Shelf position
Cooked ham 1000 g	99	55 - 65	2
Chicken breast, poached	90	25 - 35	2
Chicken, poached, 1000 - 1200 g	99	60 - 70	2
Veal / pork loin without leg, 800 - 1000 g	90	80 - 90	2
Kasseler (smoked loin of pork), poached	90	70 - 90	2
Tafelspitz (prime boiled beef)	99	110 - 120	2
Chipolatas	80	15 - 20	2
Bavarian veal sausage (white sausage)	80	20 - 30	2
Vienna sausage	80	20 - 30	2

Eggs

Food	Temperature (°C)	Time (min)	Shelf position
Eggs, hard-boiled	99	18 - 21	2
Eggs, medium-boiled	99	12 - 13	2
Eggs, soft-boiled	99	10 - 11	2

11.9 Turbo Grilling and Full Steam combined

You can combine these functions to cook meat, vegetables and side dishes at one time.

- Set the function: Turbo Grilling to roast meat.
- Add the prepared vegetables and side dishes.
- Cool down the oven to a temperature of around 90 °C. You can open the

oven door to the first position for approximately 15 minutes.

- Set the function: Full Steam. Cook all dishes together until they are ready.

Food	Turbo Grilling (first step: cook meat)			Humidity High (second step: add vegetables)		
	Temperature (°C)	Time (min)	Shelf position	Temperature (°C)	Time (min)	Shelf position
Roast beef 1 kg Brussels sprouts, polenta	180	60 - 70	meat: 1	99	40 - 50	meat: 1 vegetables: 3
Roast pork 1 kg, Potatoes, vegetables, gravy	180	60 - 70	meat: 1	99	30 - 40	meat: 1 vegetables: 3
Roast veal 1 kg, Rice, vegetables	180	50 - 60	meat: 1	99	30 - 40	meat: 1 vegetables: 3

11.10 Humidity Low

Food	Temperature (°C)	Time (min)	Shelf position
Roast pork 1000 g	160 - 180	90 - 100	2
Roast beef 1000 g	180 - 200	60 - 90	2
Roast veal 1000 g	180	80 - 90	2
Meat loaf, uncooked, 500 g	180	30 - 40	2
Smoked loin of pork 600 - 1000 g (soak for 2 hours)	160 - 180	60 - 70	2
Chicken 1000 g	180 - 210	50 - 60	2
Duck 1500 - 2000 g	180	70 - 90	2
Goose 3000 g	170	130 - 170	1
Potato gratin	160 - 170	50 - 60	2
Pasta bake	170 - 190	40 - 50	2
Lasagne	170 - 180	45 - 55	2

Food	Temperature (°C)	Time (min)	Shelf position
Misc. types of bread 500 - 1000 g	180 - 190	45 - 60	2
Bread rolls	180 - 210	25 - 35	2
Ready-to-bake rolls	200	15 - 20	2
Ready-to-bake bagu- ettes 40 - 50 g	200	15 - 20	2
Ready-to-bake bagu- ettes 40 - 50 g, fro- zen	200	25 - 35	2

11.11 Humidity Cooking - Humidity High

Food	Temperature (°C)	Time (min)	Shelf position
Custard / flan in individual dishes ¹⁾	90	35 - 45	2
Baked eggs ¹⁾	90 - 110	15 - 30	2
Terrine ¹⁾	90	40 - 50	2
Thin fish fillet	85	15 - 25	2
Thick fish fillet	90	25 - 35	2
Small fish up to 0,35 kg	90	20 - 30	2
Whole fish up to 1 kg	90	30 - 40	2
Oven dumplings	120 - 130	40 - 50	2

¹⁾ Continue for a further half an hour with the door closed.

11.12 Humidity Cooking - Humidity Medium

Food	Temperature (°C)	Time (min)	Shelf position
Various types of bread 0,5 - 1kg	180 - 190	45 - 60	2
Bread rolls	180 - 200	25 - 35	2
Sweet bread	160 - 170	30 - 45	2
Sweet yeast dough bakeries	170 - 180	20 - 35	2

Food	Temperature (°C)	Time (min)	Shelf position
Sweet oven dishes	160 - 180	45 - 60	2
Stewed / braised meat	140 - 150	100 - 140	2
Spare ribs	140 - 150	75 - 100	2
Roasted fish fillet	170 - 180	25 - 40	2
Roasted fish	170 - 180	35 - 45	2

11.13 Steam Regenerating

Food	Temperature (°C)	Time (min)	Shelf position
One-plate dishes	110	10 - 15	2
Pasta	110	10 - 15	2
Rice	110	10 - 15	2
Dumplings	110	15 - 25	2

11.14 Yogurt Function

This function allows you to prepare yogurt.

Mix 0.25 kg of yogurt with 1 l of milk. Fill it in yogurt jars.

If you use raw milk, boil it first and let it cool down to 40 °C.

Use second shelf position.

Set the temperature to 42 °C.

Food	Time (h)
Yogurt, creamy	5 - 6
Yogurt, thick	7 - 8

11.15 Baking

- Use the lower temperature the first time.
- You can extend baking times by 10 – 15 minutes if you bake cakes on more than one shelf position.
- Cakes and pastries at different heights do not always brown equally. There is no need to change the temperature setting if an unequal browning occurs. The differences equalize during baking.
- Trays in the oven can twist during baking. When the trays become cold again, the distortions disappear.

11.16 Tips on baking

Baking results	Possible cause	Remedy
The bottom of the cake is not browned sufficiently.	The shelf position is incorrect.	Put the cake on a lower shelf.
The cake sinks and becomes soggy, lumpy or streaky.	The oven temperature is too high.	The next time you bake, set a slightly lower oven temperature.

Baking results	Possible cause	Remedy
The cake sinks and becomes soggy, lumpy or streaky.	The baking time is too short.	Set a longer baking time. You cannot decrease baking times by setting higher temperatures.
The cake sinks and becomes soggy, lumpy or streaky.	There is too much liquid in the mixture.	Use less liquid. Be careful with mixing times, especially if you use a mixing machine.
The cake is too dry.	The oven temperature is too low.	The next time you bake, set a higher oven temperature.
The cake is too dry.	The baking time is too long.	The next time you bake, set a shorter baking time.
The cake browns unevenly.	The oven temperature is too high and the baking time is too short.	Set a lower oven temperature and a longer baking time.
The cake browns unevenly.	The mixture is unevenly distributed.	Spread the mixture evenly on the baking tray.
The cake is not ready in the baking time given.	The oven temperature is too low.	The next time you bake, set a slightly higher oven temperature.

11.17 Baking on one level

Baking in tins

Food	Function	Temperature (°C)	Time (min)	Shelf position
Ring cake / Brioche	True Fan Cooking	150 - 160	50 - 70	1
Madeira cake / Fruit cakes	True Fan Cooking	140 - 160	70 - 90	1
Flan base - short pastry	True Fan Cooking	150 - 160 ¹⁾	20 - 30	2
Flan base - sponge mixture	True Fan Cooking	150 - 170	20 - 25	2
Cheesecake	Conventional Cooking	170 - 190	60 - 90	1

¹⁾ Preheat the oven.

Cakes / pastries / breads on baking trays

Food	Function	Temperature (°C)	Time (min)	Shelf position
Plaited bread / Bread crown	Conventional Cooking	170 - 190	30 - 40	3
Christmas stollen	Conventional Cooking	160 - 180 ¹⁾	50 - 70	2
Bread (rye bread): 1. First 20 minutes: 2. After that reduce to:	Conventional Cooking	1. 230 ¹⁾ 2. 160 - 180	1. 20 2. 30 - 60	1
Cream puffs / Eclairs	Conventional Cooking	190 - 210 ¹⁾	20 - 35	3
Swiss roll	Conventional Cooking	180 - 200 ¹⁾	10 - 20	3
Cake with crumble topping (dry)	True Fan Cooking	150 - 160	20 - 40	3
Buttered almond cake / Sugar cakes	Conventional Cooking	190 - 210 ¹⁾	20 - 30	3
Fruit flans	Conventional Cooking	180	35 - 55	3
Yeast cakes with toppings (e.g. quark, cream, custard)	Conventional Cooking	160 - 180 ¹⁾	40 - 60	3

¹⁾ Preheat the oven.

Biscuits

Food	Function	Temperature (°C)	Time (min)	Shelf position
Short pastry / sponge mixture	True Fan Cooking	150 - 160	15 - 25	3
Meringues	True Fan Cooking	80 - 100	120 - 150	3
Macaroons	True Fan Cooking	100 - 120	30 - 50	3
Yeast dough biscuits	True Fan Cooking	150 - 160	20 - 40	3

Food	Function	Temperature (°C)	Time (min)	Shelf position
Puff pastries	True Fan Cooking	170 - 180 ¹⁾	20 - 30	3
Rolls	Conventional Cooking	190 - 210 ¹⁾	10 - 25	3

¹⁾ Preheat the oven.

11.18 Bakes and gratins

Food	Function	Temperature (°C)	Time (min)	Shelf position
Pasta bake	Conventional Cooking	180 - 200	45 - 60	1
Lasagne	Conventional Cooking	180 - 200	25 - 40	1
Vegetables au gratin ¹⁾	Turbo Grilling	170 - 190	15 - 35	1
Baguettes topped with melted cheese	True Fan Cooking	160 - 170	15 - 30	1
Sweet bakes	Conventional Cooking	180 - 200	40 - 60	1
Fish bakes	Conventional Cooking	180 - 200	30 - 60	1
Stuffed vegetables	True Fan Cooking	160 - 170	30 - 60	1

¹⁾ Preheat the oven.

11.19 Moist Fan Baking

Food	Temperature (°C)	Time (min)	Shelf position
Pasta gratin	200 - 220	45 - 55	3
Potato gratin	180 - 200	70 - 85	3
Moussaka	170 - 190	70 - 95	3
Lasagne	180 - 200	75 - 90	3
Cannelloni	180 - 200	70 - 85	3
Bread pudding	190 - 200	55 - 70	3

Food	Temperature (°C)	Time (min)	Shelf position
Rice pudding	170 - 190	45 - 60	3
Apple cake, made with sponge mixture (round cake tin)	160 - 170	70 - 80	3
White bread	190 - 200	55 - 70	3

11.20 Multilevel Baking

Use the function: True Fan Cooking.

Cakes / pastries / breads on baking trays

Food	Temperature (°C)	Time (min)	Shelf position	
			2 positions	3 positions
Cream puffs / Eclairs	160 - 180 ¹⁾	25 - 45	1 / 4	-
Dry streusel cake	150 - 160	30 - 45	1 / 4	-

¹⁾ Preheat the oven.

Biscuits / small cakes / small cakes / pastries / rolls

Food	Temperature (°C)	Time (min)	Shelf position	
			2 positions	3 positions
Short pastry biscuits	150 - 160	20 - 40	1 / 4	1 / 3 / 5
Short bread / Short bread / Pastry Stripes	140	25 - 45	1 / 4	1 / 3 / 5
Biscuits made with sponge mixture	160 - 170	25 - 40	1 / 4	-
Biscuits made with egg white, meringues	80 - 100	130 - 170	1 / 4	-
Macaroons	100 - 120	40 - 80	1 / 4	-
Biscuits made with yeast dough	160 - 170	30 - 60	1 / 4	-
Puff pastries	170 - 180 ¹⁾	30 - 50	1 / 4	-

Food	Temperature (°C)	Time (min)	Shelf position	
			2 positions	3 positions
Rolls	180	20 - 30	1 / 4	-
Small cakes / Small cakes (20 per tray)	150 ¹⁾	23 - 40	1 / 4	-

¹⁾ Preheat the oven.

11.21 Crispy baking with Pizza Setting

Food	Temperature (°C)	Time (min)	Shelf position
Pizza (thin)	210 - 230 ¹⁾²⁾	15 - 25	2
Pizza (thick)	180 - 200	20 - 30	2
Tarts	180 - 200	40 - 55	1
Spinach flan	160 - 180	45 - 60	1
Quiche Lorraine / Swiss Flan	170 - 190	45 - 55	1
Apple cake, covered	150 - 170	50 - 60	1
Vegetable pie	160 - 180	50 - 60	1
Unleavened bread	210 - 230 ¹⁾	10 - 20	2
Puff pastry flan	160 - 180 ¹⁾	45 - 55	2
Flammekuchen	210 - 230 ¹⁾	15 - 25	2
Pierogi	180 - 200 ¹⁾	15 - 25	2

¹⁾ Preheat the oven.

²⁾ Use a deep pan.

11.22 Roasting

Use heat-resistant ovenware.

Roast large roasting joints directly in the tray or on the wire shelf placed above the tray.

Put some water in the tray to prevent the meat juices or fat from burning.

Meat with crackling can be roasted in the roasting tin without the lid.

Turn the roast after 1/2 - 2/3 of the cooking time.

To keep meat more succulent:

- roast lean meat in the roasting tin with the lid or use roasting bag.
- roast meat and fish in large pieces (1 kg or more).
- baste large roasts and poultry with their juices several times during roasting.

11.23 Roasting tables

Beef

Food	Quantity	Function	Temperature (°C)	Time (min)	Shelf position
Pot roast	1 - 1.5 kg	Conventional Cooking	230	120 - 150	1
Roast beef or fillet: rare	per cm of thickness	Turbo Grilling	190 - 200 ¹⁾	5 - 6	1
Roast beef or fillet: medium	per cm of thickness	Turbo Grilling	180 - 190 ¹⁾	6 - 8	1
Roast beef or fillet: well done	per cm of thickness	Turbo Grilling	170 - 180 ¹⁾	8 - 10	1

¹⁾ Preheat the oven.

Pork

Food	Quantity	Function	Temperature (°C)	Time (min)	Shelf position
Shoulder / Neck / Ham joint	1 - 1.5 kg	Turbo Grilling	150 - 170	90 - 120	1
Chop / Spare rib	1 - 1.5 kg	Turbo Grilling	170 - 190	30 - 60	1
Meatloaf	750 g - 1 kg	Turbo Grilling	160 - 170	50 - 60	1
Pork knuckle (precooked)	750 g - 1 kg	Turbo Grilling	150 - 170	90 - 120	1

Veal

Food	Quantity (kg)	Function	Temperature (°C)	Time (min)	Shelf position
Roast veal	1	Turbo Grilling	160 - 180	90 - 120	1
Knuckle of veal	1.5 - 2	Turbo Grilling	160 - 180	120 - 150	1

Lamb

Food	Quantity (kg)	Function	Temperature (°C)	Time (min)	Shelf position
Leg of lamb / Roast lamb	1 - 1.5	Turbo Grilling	150 - 170	100 - 120	1

Food	Quantity (kg)	Function	Temperature (°C)	Time (min)	Shelf position
Saddle of lamb	1 - 1.5	Turbo Grilling	160 - 180	40 - 60	1

Game

Food	Quantity	Function	Temperature (°C)	Time (min)	Shelf position
Saddle / Leg of hare	up to 1 kg	Turbo Grilling	180 - 200 ¹⁾	35 - 55	1
Saddle of venison	1.5 - 2 kg	Conventional Cooking	180 - 200	60 - 90	1
Haunch of venison	1.5 - 2 kg	Conventional Cooking	180 - 200	60 - 90	1

¹⁾ Preheat the oven.

Poultry

Food	Quantity	Function	Temperature (°C)	Time (min)	Shelf position
Poultry portions	200 - 250 g each	Turbo Grilling	200 - 220	30 - 50	1
Half chicken	400 - 500 g each	Turbo Grilling	190 - 210	40 - 50	1
Chicken, poulard	1 - 1.5 kg	Turbo Grilling	190 - 210	50 - 70	1
Duck	1.5 - 2 kg	Turbo Grilling	180 - 200	80 - 100	1
Goose	3.5 - 5 kg	Turbo Grilling	160 - 180	120 - 180	1
Turkey	2.5 - 3.5 kg	Turbo Grilling	160 - 180	120 - 150	1
Turkey	4 - 6 kg	Turbo Grilling	140 - 160	150 - 240	1

Fish (steamed)

Food	Quantity (kg)	Function	Temperature (°C)	Time (min)	Shelf position
Whole fish	1 - 1.5	Turbo Grilling	180 - 200	30 - 50	1

11.24 Grill

Preheat the empty oven for 5 minutes.

Put the pan to collect the fat into the first shelf position.

Grill

Food	Temperature (°C)	Time (min)		Shelf position
		1st side	2nd side	
Roast beef	210 - 230	30 - 40	30 - 40	2
Filet of beef	230	20 - 30	20 - 30	3
Back of pork	210 - 230	30 - 40	30 - 40	2
Back of veal	210 - 230	30 - 40	30 - 40	2
Back of lamb	210 - 230	25 - 35	20 - 25	3
Whole Fish, 0.5 - 1 kg	210 - 230	15 - 30	15 - 30	3 / 4

Fast Grilling

Preheat the empty oven for 3 minutes.

Grill with the maximum temperature setting.

Food	Time (min)		Shelf position
	1st side	2nd side	
Pork fillet	10 - 12	6 - 10	4
Sausages	10 - 12	6 - 8	4
Fillet / Veal steaks	7 - 10	6 - 8	4
Toast with topping	6 - 8	-	4

11.25 Frozen Foods

Food	Temperature (°C)	Time (min)	Shelf position
Pizza, frozen	200 - 220	15 - 25	2
Pizza American, frozen	190 - 210	20 - 25	2
Pizza, chilled	210 - 230	13 - 25	2
Pizza Snacks, frozen	180 - 200	15 - 30	2
French Fries, thin	190 - 210	15 - 25	3
French Fries, thick	190 - 210	20 - 30	3
Wedges / Croquettes	190 - 210	20 - 40	3

Food	Temperature (°C)	Time (min)	Shelf position
Hash Browns	210 - 230	20 - 30	3
Lasagne / Cannelloni, fresh	170 - 190	35 - 45	2
Lasagne / Cannelloni, frozen	160 - 180	40 - 60	2
Oven baked cheese	170 - 190	20 - 30	3
Chicken Wings	180 - 200	40 - 50	2

Frozen ready meals

Food	Function	Temperature (°C)	Time (min)	Shelf position
Frozen pizza	Conventional Cooking	as per manufacturer's instructions	as per manufacturer's instructions	3
French fries ¹⁾ (300 - 600 g)	Conventional Cooking or Turbo Grilling	200 - 220	as per manufacturer's instructions	3
Baguettes	Conventional Cooking	as per manufacturer's instructions	as per manufacturer's instructions	3
Fruit flans	Conventional Cooking	as per manufacturer's instructions	as per manufacturer's instructions	3

¹⁾ Turn the French fries 2 or 3 times during cooking.

11.26 Slow Cooking

Use this function to prepare lean, tender pieces of meat and fish with core temperatures no more than 65 °C. This function is not applicable to such recipes as pot roast or fatty roast pork. You can use the core temperature sensor to guarantee that the meat has the correct core temperature (see the table for the core temperature sensor).

In the first 10 minutes you can set an oven temperature between 80 °C and 150 °C. The default is 90 °C. After the temperature is set, the oven continues to cook at 80 °C. Do not use this function for poultry.



Always cook without a lid when you use this function.

1. Sear the meat in a pan on the hob on a very high setting for 1 - 2 minutes on each side.
2. Put the meat together with the hot roasting pan in the oven and on the wire shelf.
3. Put the core temperature sensor into the meat.
4. Select the function: Slow Cooking and set the correct end core temperature.

Food	Quantity (kg)	Temperature (°C)	Time (min)	Shelf position
Roast beef	1 - 1.5	120	120 - 150	1
Fillet of beef	1 - 1.5	120	90 - 150	3
Roast veal	1 - 1.5	120	120 - 150	1
Steaks	0.2 - 0.3	120	20 - 40	3

11.27 Preserving

- Use only preserve jars of the same dimensions available on the market.
- Do not use jars with twist-off and bayonet type lids or metal tins.
- Use the first shelf from the bottom for this function.
- Put no more than six one-litre preserve jars on the baking tray.
- Fill the jars equally and close with a clamp.
- The jars cannot touch each other.
- Put approximately 1/2 litre of water into the baking tray to give sufficient moisture in the oven.
- When the liquid in the jars starts to simmer (after approximately 35 - 60 minutes with one-litre jars), stop the oven or decrease the temperature to 100 °C (see the table).

Soft fruit

Food	Temperature (°C)	Cooking time until simmering (min)	Continue to cook at 100 °C (min)
Strawberries / Blueberries / Raspberries / Ripe gooseberries	160 - 170	35 - 45	-

Stone fruit

Food	Temperature (°C)	Cooking time until simmering (min)	Continue to cook at 100 °C (min)
Pears / Quinces / Plums	160 - 170	35 - 45	10 - 15

Vegetables

Food	Temperature (°C)	Cooking time until simmering (min)	Continue to cook at 100 °C (min)
Carrots ¹⁾	160 - 170	50 - 60	5 - 10
Cucumbers	160 - 170	50 - 60	-
Mixed pickles	160 - 170	50 - 60	5 - 10
Kohlrabi / Peas / Asparagus	160 - 170	50 - 60	15 - 20

¹⁾ Leave standing in the oven after it is deactivated.

11.28 Drying

- Cover trays with grease proof paper or baking parchment.
- For a better result, stop the oven halfway through the drying time, open

the door and let it cool down for one night to complete the drying.

Vegetables

Food	Temperature (°C)	Time (h)	Shelf position	
			1 position	2 positions
Beans	60 - 70	6 - 8	3	1 / 4
Peppers	60 - 70	5 - 6	3	1 / 4
Vegetables for sour	60 - 70	5 - 6	3	1 / 4
Mushrooms	50 - 60	6 - 8	3	1 / 4
Herbs	40 - 50	2 - 3	3	1 / 4

Fruit

Food	Temperature (°C)	Time (h)	Shelf position	
			1 position	2 positions
Plums	60 - 70	8 - 10	3	1 / 4
Apricots	60 - 70	8 - 10	3	1 / 4
Apple slices	60 - 70	6 - 8	3	1 / 4
Pears	60 - 70	6 - 9	3	1 / 4

11.29 Bread Baking

Preheating is not recommended.

Food	Temperature (°C)	Time (min)	Shelf position
White Bread	170 - 190	40 - 60	2
Baguette	200 - 220	35 - 45	2
Brioche	180 - 200	40 - 60	2
Ciabatta	200 - 220	35 - 45	2
Rye Bread	170 - 190	50 - 70	2
Dark Bread	170 - 190	50 - 70	2
All Grain bread	170 - 190	40 - 60	2
Bread rolls	190 - 210	20 - 35	2

11.30 Food Sensor table

Beef	Food core temperature (°C)		
	Rare	Medium	Well done
Roast beef	45	60	70
Sirloin	45	60	70

Beef	Food core temperature (°C)		
	Less	Medium	More
Meat loaf	80	83	86

Pork	Food core temperature (°C)		
	Less	Medium	More
Ham, Roast	80	84	88
Chop (saddle), Smoked pork loin, Smoked loin poached	75	78	82

Veal	Food core temperature (°C)		
	Less	Medium	More
Roast veal	75	80	85
Knuckle of veal	85	88	90

Mutton / lamb	Food core temperature (°C)		
	Less	Medium	More
Leg of mutton	80	85	88
Saddle of mutton	75	80	85
Leg of lamb, Roast lamb	65	70	75

Game	Food core temperature (°C)		
	Less	Medium	More
Saddle of hare, Saddle of venison	65	70	75
Leg of hare, Whole hare, Leg of venison	70	75	80

Poultry	Food core temperature (°C)		
	Less	Medium	More
Chicken (whole / half / breast)	80	83	86
Duck (whole / half), Turkey (whole / breast)	75	80	85
Duck (breast)	60	65	70

Fish (salmon, trout, zander)	Food core temperature (°C)		
	Less	Medium	More
Fish (whole / large / steamed), Fish (whole / large / roasted)	60	64	68

Casseroles - Precooked vegeta- bles	Food core temperature (°C)		
	Less	Medium	More
Zucchini Casserole, Broccoli Casserole, Fennel Casserole	85	88	91

Casseroles - Savoury	Food core temperature (°C)		
	Less	Medium	More
Cannelloni, Lasagne, Pasta bake	85	88	91

Casseroles - Sweet	Food core temperature (°C)		
	Less	Medium	More
White bread casserole with / with- out fruits, Rice porridge casserole with / without fruits, Sweet noodle casserole	80	85	90

11.31 Information for test institutes

Tests according to IEC 60350-1.

Tests for the function: Humidity High.

Food	Container (Gastro-norm)	Quantity (g)	Shelf position	Temperature (°C)	Time (min)	Comments
Broccoli ¹⁾	1 x 2/3 perforated	300	3	99	13 - 15	Put the baking tray on the first shelf position.
Broccoli ¹⁾	2 x 2/3 perforated	2 x 300	2 and 4	99	13 - 15	Put the baking tray on the first shelf position.
Broccoli ¹⁾	1 x 2/3 perforated	max.	3	99	15 - 18	Put the baking tray on the first shelf position.
Frozen peas	2 x 2/3 perforated	2 x 1500	2 and 4	99	Until the temperature in the coldest spot reaches 85 °C.	Put the baking tray on the first shelf position.

¹⁾ Preheat the oven for 5 minutes.

12. CARE AND CLEANING



WARNING!
Refer to Safety chapters.

12.1 Notes on cleaning

- Clean the front of the oven with a soft cloth with warm water and a mild cleaning agent.
- To clean metal surfaces, use a dedicated cleaning agent.
- To clean the bottom side in case of limestone residual, use some drops of vinegar.
- Clean the oven interior after each use. Fat accumulation or other food remains may result in a fire. The risk is higher for the grill pan.
- Clean stubborn dirt with a special oven cleaner.
- Clean all accessories after each use and let them dry. Use a soft cloth with warm water and a cleaning agent.

- If you have nonstick accessories, do not clean them using aggressive agents, sharp-edged objects or a dishwasher. It can cause damage to the nonstick coating.
- Dry the oven when the cavity is wet after usage.

12.2 Recommended cleaning products

Do not use abrasive sponges or aggressive detergents. It can cause damage to the enamel and the stainless steel parts.

You can buy our products at www.aeg.com/shop and at the best retailer shops.

12.3 Removing the shelf supports

Before maintenance, make sure that the oven is cool. There is a risk of burns.

To clean the oven, remove the shelf supports.

1. Pull carefully the supports up and out of the front catch.

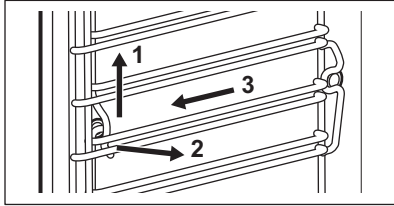

2. Pull the front end of the shelf support away from the side wall.
3. Pull the supports out of the rear catch.

Install the shelf supports in the opposite sequence.

12.4 Steam Cleaning

Remove as much dirt as possible manually.

Remove the accessories and the shelf support to clean the side walls.

The steam cleaning functions support the steam cavity cleaning of the oven.

- i** Before you start a cleaning procedure, make sure that the oven is cool.

When the steam cleaning function works, the light is off.

1. Fill the water drawer to the maximum level.
2. Choose the steam cleaning function in the menu: Cleaning.
 - Steam Cleaning** - the duration of the function is around 30 minutes.
 - a) Turn on the function.
 - b) When the programme ends a signal sounds.
 - c) Press a sensor field to turn off the signal.

Steam Cleaning Plus - the duration of the function is around 75 minutes.

- a) Spray a suitable detergent uniformly in the oven cavity on both enamel and steel parts.
- b) Turn on the function. After around 50 minutes a signal sounds. The first part of the programme ends.
- c) Press **OK**.

- i** This is not the end of the cleaning procedure. Follow the message in the display to complete the cleaning.

- d) Wipe the cavity of the oven with a non-abrasive surface care sponge. You can use warm water or oven detergents.
 - e) Press **OK**. The final part of the procedure starts. The duration of this stage is around 25 minutes.
3. Wipe the cavity of the oven with a non-abrasive sponge. You can use warm water.
 4. Remove the remaining water from the water drawer. After cleaning keep the oven door open for approximately 1 hour. Wait until the oven is dry. To speed up the drying you can heat up the oven with hot air at temperature 150 °C for approximately 15 minutes. You can get maximum effects of the cleaning function if you manually clean the oven immediately after the function ends.

12.5 Cleaning Reminder

When reminder is displayed cleaning is necessary. Perform the function Steam Cleaning Plus.

You can enable / disable the function: Cleaning Reminder in the menu: Basic Settings.

12.6 Cleaning the water drawer

Remove the water drawer from the appliance.

1. Remove the lid of the water drawer. Lift the cover in correspondence with the protrusion in the rear.

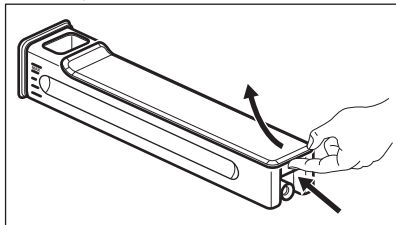

2. Remove the wave-breaker. Pull it away from the drawer body until it snaps out.
3. Wash the water drawer parts with your hands. Use tap water and soap.

i Do not use abrasive sponges. Do not put water drawer inside a dishwasher.

After you clean the water drawer parts, reassemble the water drawer.

1. Snap in the wave-breaker. Push it into the drawer body.
2. Assemble the lid. First insert the front snap and then push it against the drawer body.

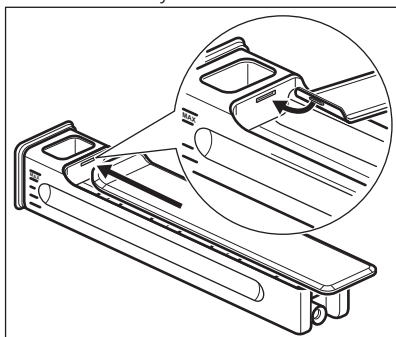

3. Insert the water drawer inside the appliance.
4. Push the water drawer towards the oven until it latches.

12.7 Steam generation system - Descaling

When the steam generator operates, limestone accumulates inside it (because of calcium contents in the water). This can have a negative effect on the steam

quality, on the performance of the steam generator and on the food quality. To prevent limestone accumulation, clean the steam generation circuit.

Remove all accessories.

Select the function from the menu: Cleaning. The user interface will guide you through the procedure.

The duration of the complete procedure is about 2 hours.

The light in this function is off.

1. Put the grill- / roasting pan on the first shelf position.
2. Press **OK**.
3. Put 250 ml of the descaling agent in the water drawer.
4. Fill the remaining part of the water drawer with water to the maximum level.
5. Insert the water drawer.
6. Press **OK**.
This activates the first part of the procedure: Descaling.

i The duration of this part is around 1 hour 40 minutes.

7. After the end of the first part, empty the grill- / roasting pan and put it on the first shelf position again.
8. Press **OK**.
9. Fill the water drawer with fresh water. Make sure there is no remaining cleaning solution inside the water drawer.
10. Insert the water drawer.
11. Press **OK**.
This activates the second part of the procedure: Descaling. It will rinse the steam generation circuit.

i The duration of this part is around 35 minutes.

Remove the grill- / roasting pan after the end of the procedure.

i If the function: Descaling is not performed in the correct way, the display will show a message to repeat it.

If the oven is humid or wet, wipe it out with a dry cloth. Let the oven dry fully with the door open.

12.8 Descaling reminder

There are two descaling reminders which remind you to perform the function: Descaling. These reminders activate each time you switch off the appliance.

The soft reminder reminds and recommends you to perform the descaling cycle.

The hard reminder obligates you to perform the descaling.

- i** If you do not descale the appliance when the hard reminder is on, you cannot use the steam functions. You cannot disable the descaling reminder.

12.9 Steam generation system - Rinsing

Remove all accessories.

Select the function from the menu: Cleaning. The user interface will guide you through the procedure.

The duration of the function is around 30 minutes.

The light in this function is off.

1. Put the baking tray on the first shelf position.
2. Press **OK**.
3. Fill the water drawer with fresh water.
4. Press **OK**.

Remove the baking tray after the end of the procedure.

12.10 Removing and installing the door

You can remove the door and the internal glass panels to clean it. The number of glass panels is different for different models.



WARNING!

Be careful when you remove the door from the appliance. The door is heavy.

1. Open the door fully.
2. Fully press the clamping levers (A) on the two door hinges.

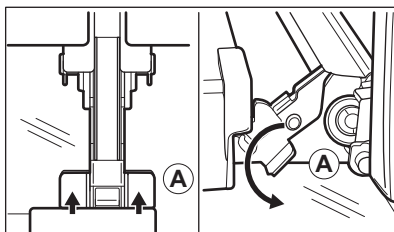

3. Close the oven door to the first opening position (approximately 70° angle).
4. Hold the door with one hand on each side and pull it away from the appliance at an upwards angle.
5. Put the door with the outer side down on a soft cloth on a stable surface. This is to prevent scratches.
6. Hold the door trim (B) on the top edge of the door at the two sides and push inwards to release the clip seal.

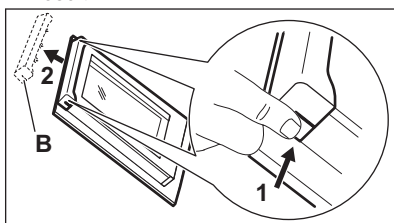

7. Pull the door trim to the front to remove it.
8. Hold the door glass panels on their top edge one by one and pull them up out of the guide.

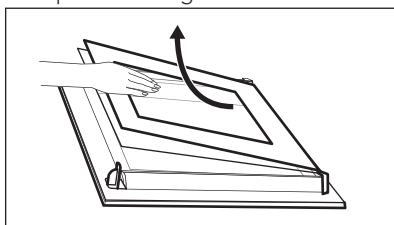

9. Clean the glass panel with water and soap. Dry the glass panel carefully. When the cleaning is completed, do the above steps in the opposite sequence. Install the smaller panel first, then the larger and the door.

**WARNING!**

Make sure that the glasses are inserted in the correct position otherwise the surface of the door may overheat.

12.11 Replacing the lamp

**WARNING!**

Risk of electric shock.
The lamp can be hot.

1. Turn off the oven.
Wait until the oven is cooled down.
2. Disconnect the oven from the mains.
3. Put a cloth on the bottom of the cavity.

The top lamp

1. Turn the lamp glass cover to remove it.

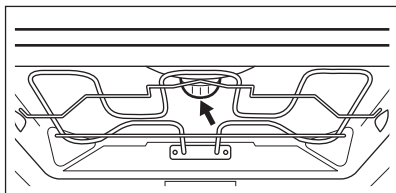

2. Remove the metal ring and clean the glass cover.
3. Replace the lamp with a suitable 300 °C heat-resistant lamp.
4. Attach the metal ring to the glass cover.
5. Install the glass cover.

The side lamp

1. Remove the left shelf support to get access to the lamp.
2. Use a Torx 20 screwdriver to remove the cover.
3. Remove and clean the metal frame and the seal.
4. Replace the lamp with a suitable 300 °C heat-resistant lamp.
5. Install the metal frame and the seal. Tighten the screws.
6. Install the left shelf support.

13. TROUBLESHOOTING

**WARNING!**

Refer to Safety chapters.

13.1 What to do if...

Problem	Possible cause	Remedy
You cannot activate or operate the oven.	The oven is not connected to an electrical supply or it is connected incorrectly.	Check if the oven is correctly connected to the electrical supply (refer to the connection diagram if available).
The oven does not heat up.	The oven is deactivated.	Activate the oven.
The oven does not heat up.	The clock is not set.	Set the clock.
The oven does not heat up.	The necessary settings are not set.	Make sure that the settings are correct.
The oven does not heat up.	The automatic switch-off is activated.	Refer to "Automatic switch-off".

Problem	Possible cause	Remedy
The oven does not heat up.	The Child Lock is on.	Refer to "Using the Child Lock".
The oven does not heat up.	The door is not closed correctly.	Fully close the door.
The oven does not heat up.	The fuse is blown.	Make sure that the fuse is the cause of the malfunction. If the fuse is blown again and again, contact a qualified electrician.
The lamp does not operate.	The lamp is defective.	Replace the lamp.
The display shows F111.	The plug of the core temperature sensor is not correctly installed into the socket.	Put the plug of the core temperature sensor as far as possible into the socket.
The display shows an error code that is not in this table.	There is an electrical fault.	<ul style="list-style-type: none"> Deactivate the oven with the house fuse or the safety switch in the fuse box and activate it again. If the display shows the error code again, contact the Customer Care Department.
Steam and condensation settle on the food and in the cavity of the oven.	You left the dish in the oven for too long.	Do not leave the dishes in the oven for longer than 15 - 20 minutes after the cooking process ends.
The appliance does not retain the water drawer after you insert it.	You did not assemble the lid of the water drawer correctly.	Assemble the lid of the water drawer correctly.
Water comes out of the water drawer after you carry it or put it inside the appliance.	You did not assemble the lid of the water drawer correctly.	Assemble the lid of the water drawer correctly.
Water comes out of the water drawer after you carry it or put it inside the appliance.	You did not assemble the wave-breaker correctly.	Assemble the wave-breaker in the body of the water drawer correctly.
The appliance does not retain the water drawer after you push it on the cover.	You did not fully press the water drawer body.	Insert the water drawer body in the appliance by pushing it until it reaches to the end.
The water drawer is difficult to clean.	You did not remove the lid and the wave-breaker.	Refer to "Cleaning the water drawer".

Problem	Possible cause	Remedy
The descaling procedure is interrupted before it finishes.	There was a power cut.	Repeat the procedure.
The descaling procedure is interrupted before it finishes.	The function was stopped by the user.	Repeat the procedure.
There is no water inside the grill- / roasting pan after the descaling procedure.	You did not fill the water drawer to the maximum level.	Check if the a descaling agent / water is present in the water drawer body. Repeat the procedure.
There is dirty water on the bottom of the cavity after the descaling cycle.	The grill- / roasting pan is on a wrong shelf position.	Remove the residual water and the descaling agent from the bottom of the oven. Put the grill- / roasting pan on the first shelf position.
The cleaning function is interrupted before it finishes.	There was a power cut.	Repeat the procedure.
The cleaning function is interrupted before it finishes.	The function was stopped by the user.	Repeat the procedure.
There is too much water on the bottom of the cavity after the end of the cleaning function.	You sprayed too much detergent in the appliance before the activation of the cleaning cycle.	Cover all parts of the cavity with a thin layer of the detergent. Spray the detergent evenly.
There is no good performance of the cleaning procedure.	The initial oven cavity temperature of the steam cleaning function was too high.	Repeat the cycle. Run the cycle when the appliance is cold.
There is no good performance of the cleaning procedure.	You did not remove the side grids before the start of the cleaning procedure. They can transfer heat to the walls and decrease the performance.	Remove the side grids from the appliance and repeat the function.
There is no good performance of the cleaning procedure.	You did not remove the accessories from the appliance before the start of the cleaning procedure. They can compromise the steam cycle and decrease the performance.	Remove the accessories from the appliance and repeat the function.

13.2 Service data

If you cannot find a solution to the problem yourself, contact your dealer or an Authorised Service Centre.

The necessary data for the service centre is on the rating plate. The rating plate is on the front frame of the appliance cavity. Do not remove the rating plate from the appliance cavity.

We recommend that you write the data here:	
Model (MOD.)
Product number (PNC)
Serial number (S.N.)

14. ENERGY EFFICIENCY

14.1 Product Fiche and information according to EU 65-66/2014

Supplier's name	AEG	
Model identification	BSE792220B BSE792220M	
Energy Efficiency Index	81.0	
Energy efficiency class	A+	
Energy consumption with a standard load, conventional mode	1.09 kWh/cycle	
Energy consumption with a standard load, fan-forced mode	0.68 kWh/cycle	
Number of cavities	1	
Heat source	Electricity	
Volume	70 l	
Type of oven	Built-In Oven	
Mass	BSE792220B	39.5 kg
	BSE792220M	39.5 kg

EN 60350-1 - Household electric cooking appliances - Part 1: Ranges, ovens, steam ovens and grills - Methods for measuring performance.

14.2 Energy saving



The appliance contains features which help you save energy during everyday cooking.

General hints

Make sure that the oven door is closed properly when the appliance operates and keep it closed as much as possible during the cooking.

Use metal dishes to improve energy saving.

When possible, do not preheat the oven before you put the food inside.

When the cooking duration is longer than 30 minutes, reduce the oven temperature to minimum 3 - 10 minutes before the end of the cooking time, depending on the duration of the cooking. The residual heat inside the oven will continue to cook.

Use the residual heat to warm up other dishes.

Cooking with fan

When possible, use the cooking functions with fan to save energy.

Residual heat

If a programme with the Duration or End Time selection is activated and the cooking time is longer than 30 minutes, the heating elements deactivate automatically 10% faster in some oven functions.

The fan and lamp continue to operate.

Keep food warm

Choose the lowest possible temperature setting to use residual heat and keep a meal warm. The display shows the residual heat indicator or temperature.

Cooking with the lamp off

Deactivate the lamp during cooking and activate only when you need it.

Moist Fan Baking

Function designed to save energy during cooking. It operates in such a way that the temperature in the oven cavity may differ from the temperature indicated on the display during a cooking cycle and cooking times may be different from the cooking times in other programmes.

When you use Moist Fan Baking, the lamp automatically deactivates after 30 seconds.

You may activate the lamp again but this action will reduce the expected energy savings.

15. ENVIRONMENTAL CONCERNS

Recycle materials with the symbol . Put the packaging in relevant containers to recycle it. Help protect the environment and human health by recycling waste of electrical and electronic appliances. Do not dispose of

appliances marked with the symbol  with the household waste. Return the product to your local recycling facility or contact your municipal office.

www.aeg.com/shop



867 335093-D-392017



AEG